

01 EXPOSITOR DE BARRA Y PLATOS

BAR DISPLAY EXHIBITOR CASE AND PLATE

EXTERIOR

- Perfil de aluminio anodizado
- CC - Cristal curvo abatible
- CP - Cristal plano

INTERIOR

- Bandeja de exposición en acero Inox AISI 304 18/10
- Iluminación LED perfil superior 

AISLAMIENTO

- Poliuretano inyectado alta presión libre de CFC's densidad 40 kg/m³, bajo GWP y cero efecto ODP

PUERTAS

- Puertas traseras abatibles 180°

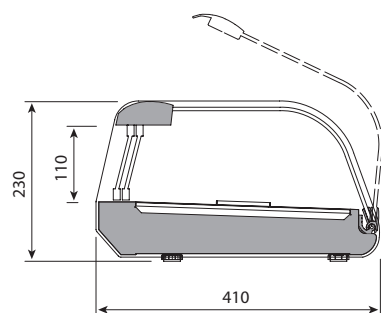

VEP

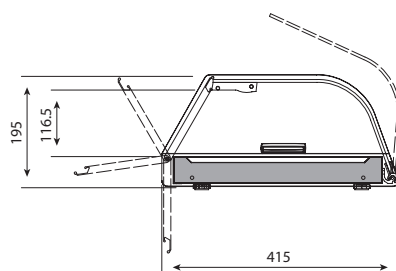

VEB - CC

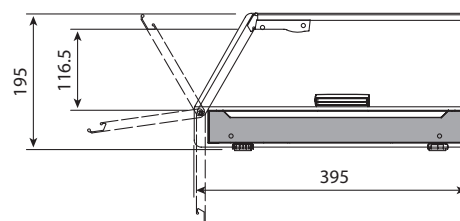

VEB - CP

EXTERIOR

- Anodized aluminium profile
- CC - Front opening curved glass
- CP - Flat glass

INTERIOR

- AISI 304 18/10 Stainless steel exhibition tray
- LED lighting upper profile 

INSULATION

- Free CFC's high density (40kg/m³) polyurethane insulation with low GWP & zero ODP effect

DOORS

- Folding back doors 180°

MODELOS MODELS	→ ↗ ↖ ↕ ⏻ ⚠	📏	⚡	📦	🖥️	🌀	❄️	💧	🌡️	🧊	🕒	🌡️
	Dimensiones Dimensions LxPxH (mm)	Potencia Power (W)	Tensión/Frecuencia Electrical (V/Hz)	Capacidad Capacity (L)	Superficie exposición (m ²)	Compresor Compressor (HP)	Potencia Frig. Cooling capacity (W) (T [°] -10°C)	Evaporación Evaporation	Régimen temperatura Temperature range (32°C)	Desescarche Defrost	Control Control	Refrigerante Coolant
VEP 4 P	1268x410x230	130	220/50	9,2	0,23	1/6	140	Placa fría Cold board	+4°C/+8°C	Manual Manual	Digital	R 134 a
VEP 6 P	1620x410x230	130	220/50	13,6	0,34	1/6	140	Placa fría Cold board	+4°C/+8°C	Manual Manual	Digital	R 134 a
VEP 8 P	1972x410x230	130	220/50	18,4	0,46	1/6	140	Placa fría Cold board	+4°C/+8°C	Manual Manual	Digital	R 134 a
VEB 4 CC	810x415x195	130	220/50	9,2	0,23	1/6	140	Placa fría Cold board	+4°C/+8°C	Manual Manual	Digital	R 134 a
VEB 6 CC	1162x415x195	130	220/50	13,6	0,34	1/6	140	Placa fría Cold board	+4°C/+8°C	Manual Manual	Digital	R 134 a
VEB 7 CC	1338x415x195	130	220/50	16,0	0,40	1/6	140	Placa fría Cold board	+4°C/+8°C	Manual Manual	Digital	R 134 a
VEB 8 CC	1514x415x195	130	220/50	18,4	0,46	1/6	140	Placa fría Cold board	+4°C/+8°C	Manual Manual	Digital	R 134 a
VEB 9 CC	1690x415x195	130	220/50	20,4	0,51	1/6	140	Placa fría Cold board	+4°C/+8°C	Manual Manual	Digital	R 134 a
VEB 4 CP	810x395x195	130	220/50	9,2	0,23	1/6	140	Placa fría Cold board	+4°C/+8°C	Manual Manual	Digital	R 134 a
VEB 6 CP	1162x395x195	130	220/50	13,6	0,34	1/6	140	Placa fría Cold board	+4°C/+8°C	Manual Manual	Digital	R 134 a
VEB 7 CP	1338x395x195	130	220/50	16,0	0,40	1/6	140	Placa fría Cold board	+4°C/+8°C	Manual Manual	Digital	R 134 a
VEB 8 CP	1514x395x195	130	220/50	18,4	0,46	1/6	140	Placa fría Cold board	+4°C/+8°C	Manual Manual	Digital	R 134 a
VEB 9 CP	1690x395x195	130	220/50	20,4	0,51	1/6	140	Placa fría Cold board	+4°C/+8°C	Manual Manual	Digital	R 134 a

Características técnicas y constructivas sujetas a variación sin previo aviso / We reserve the right to change specifications without prior notice.

EXPOSITOR DE BARRA Y PLATOS
BAR DISPLAY EXHIBITOR CASE AND PLATE



VEB 8 CC



VEB 6 CP



VEP 6 P

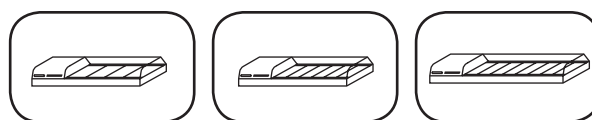

VEP 4 P

VEP 6 P

VEP 8 P

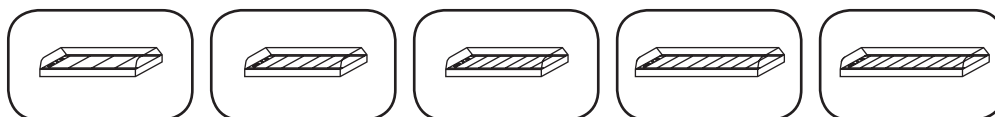

VEB 4 CC

VEB 6 CC

VEB 7 CC

VEB 8 CC

VEB 9 CC

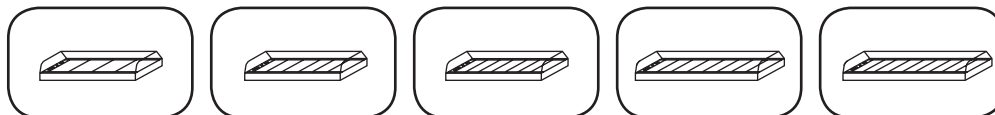

VEB 4 CP

VEB 6 CP

VEB 7 CP

VEB 8 CP

VEB 9 CP

